



LED Lighting

LF3D/LF1D

---



**LUMIFA™**

**Excellent optical performance and robust construction  
suitable for use in machine tools**

IDEC CORPORATION

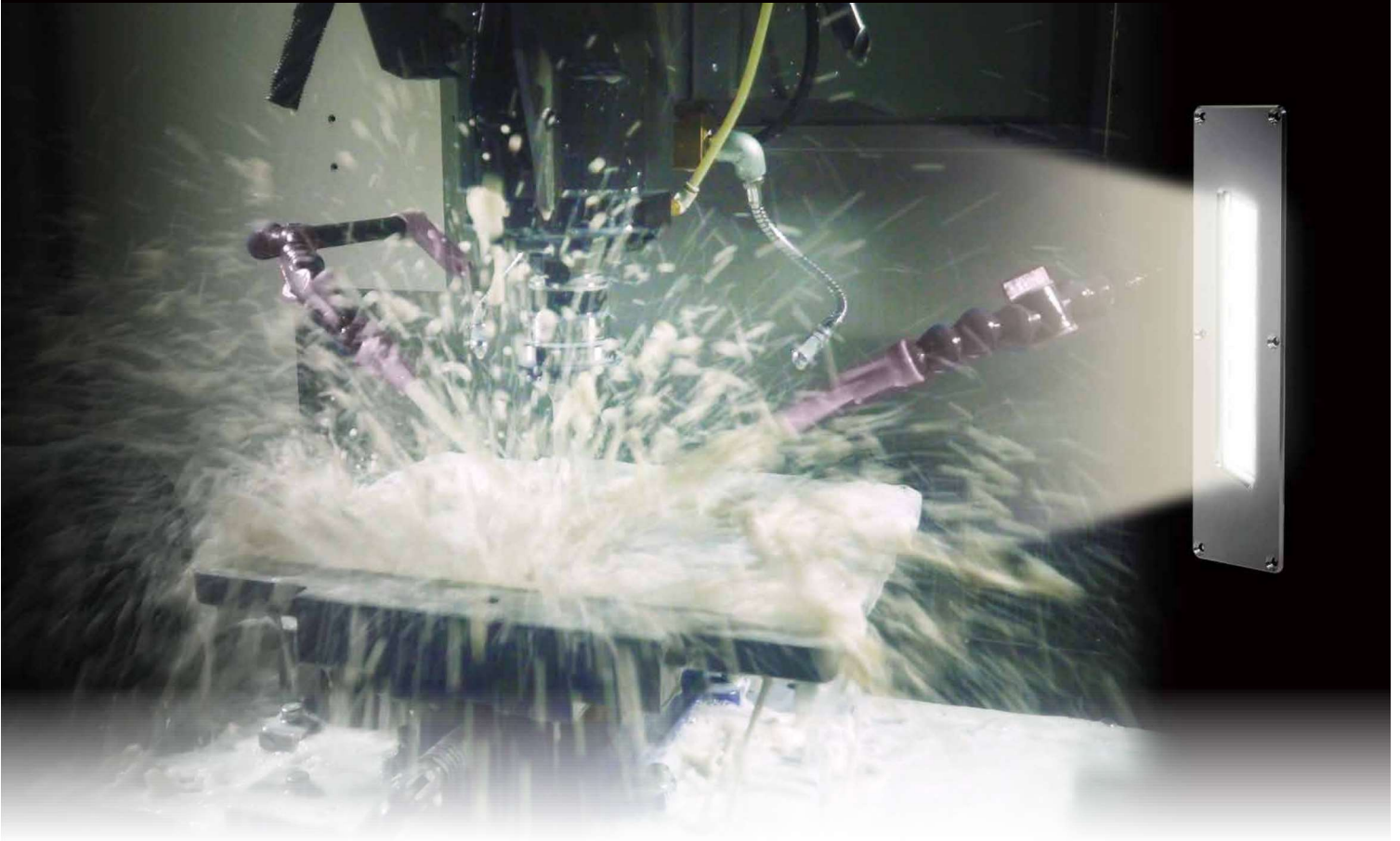

## Effective solution for machine tools

LED lighting inside machine tool allows for clear identification of chatter marks

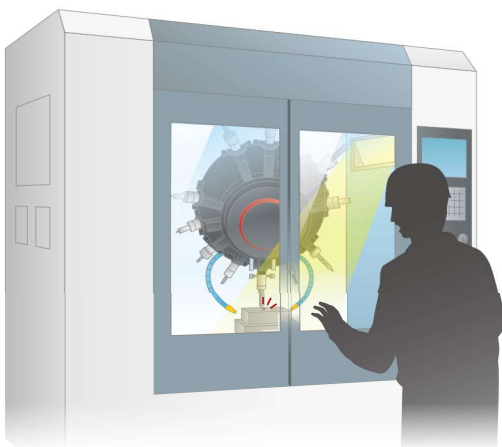

### BEFORE

- ▶ Hard to see chatter marks

Glares from LED lighting inside the machine tool could be mistaken as chatter marks while visually checking the machine operation. This often caused chatter marks to be left untreated, delaying maintenance and worsening the situation.



### AFTER

- ▶ LED lighting improves machining efficiency

IDEC's unique optical technology enables the light to shine evenly on the surface, suppressing multiple shadows and allowing the operator to see scratches and unevenness on the workpiece. LF3D lighting makes it possible to check whether chatter marks have been generated or not easily, at a glance.

Provides high-quality and uniform lighting  
on the surface of target objects  
and inside the work area



### Eliminates the multi-shadow effect

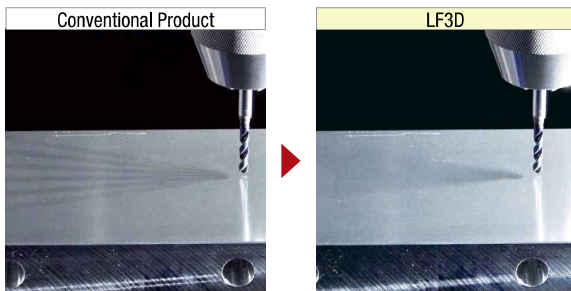

▶ Reduced multi-shadow effect enables easy visual inspection of the machined surface. [Patent pending (LF3D)]

### Reduces reflection from light source

LED light source reflects on the workpiece and stripes appear.

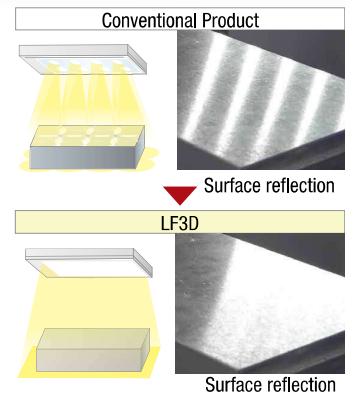

The LF3D LED allows the light to be evenly distributed to provide natural lighting, and enables visual inspection. [Patent pending (LF3D)]

### Uniform lighting provides uniform illumination inside the work area

By combining our optical design technology gained by development of LED lighting & sensors and by optimum LED alignment, the brightness contrast difference is improved by 85%.

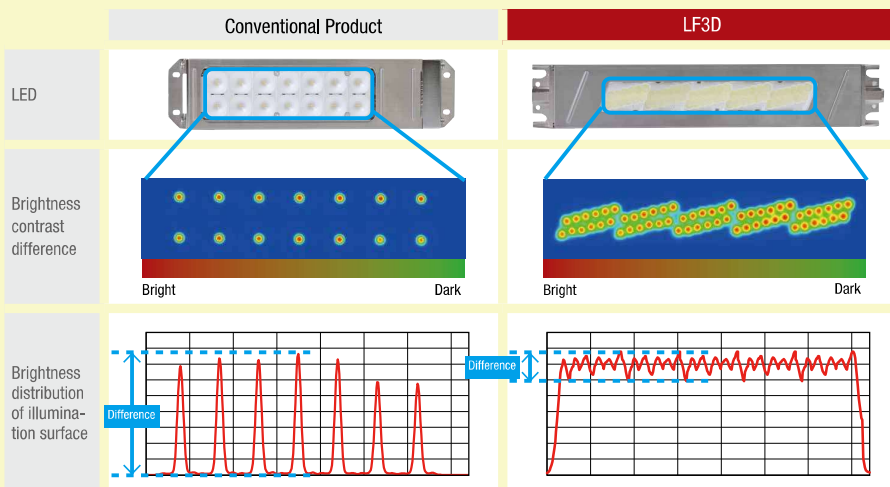

## Select from standard or diffused light distribution depending on the machine tool needs

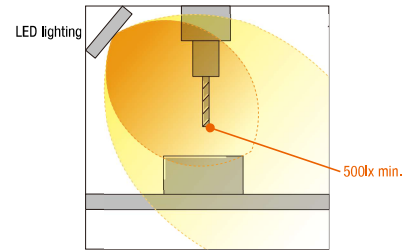
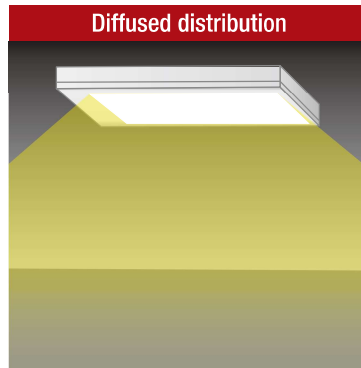
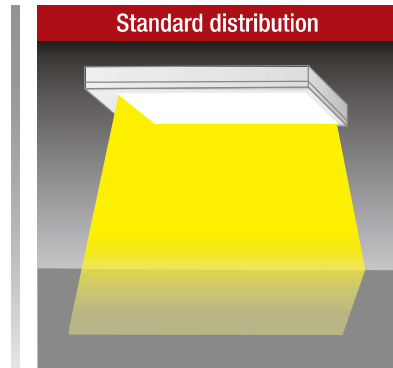

\*At least 500 lx shall be provided when arranging lighting for machines.  
(EN1837:1999+A1:2009 4.2)

## Equipped with glare mode to prevent operators from glare during maintenance

[Patent pending (LF3D)]

Modes can be changed by just the wiring. Complicated settings such as PWM and dedicated controllers are not required.

▶ Application example: Functions with opening & closing of doors / switching with control panel



\*1) Approx. 40% illumination

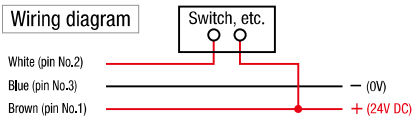

## Rugged construction and environmentally resistant

### Suitable for use in machine tools

**IP67G  
IP69K**

▶ Degree of protection IP67G / IP69K

Oil-resistant gasket and unique structural design achieves IP67G protection degree. (\*1)

Withstands exposure to water and oil. (\*2)

IP69K for use in high-pressure, high-temperature washdown.

\*1) IP67F (LF1D)

\*2) Oil used for testing: Insoluble oil JIS N3-8

**Robust**

▶ Robust material

Reinforced glass, stainless steel, zinc diecast, extruded aluminum prevents damage from scraps

**High temp.**

▶ Resistant to high temperature

Wide operating temperature range (up to 55°C).

## Improved design and user-friendly

### Compact, slim, and light compared to conventional products

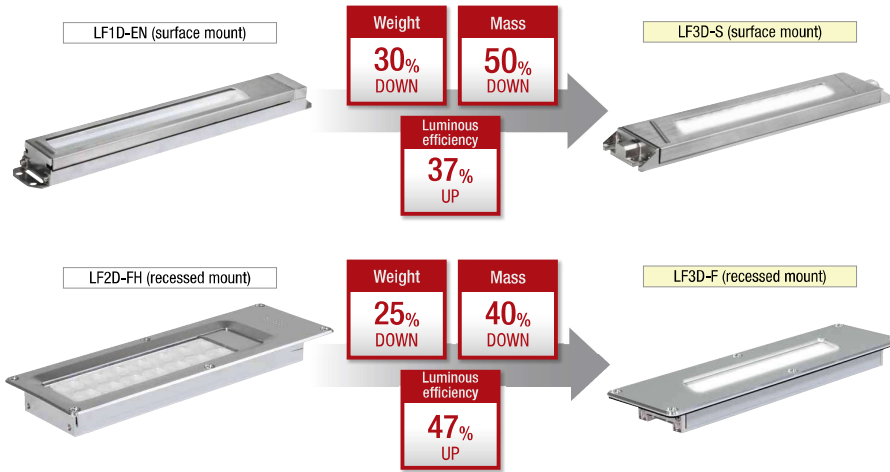

### Easy replacement with conventional products

Panel cut-out for older LED lighting will fit the new LF3D LED.

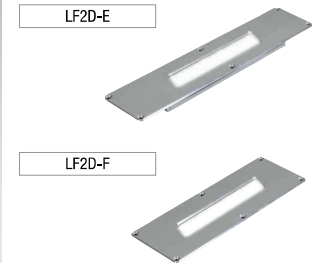

Accessories for surface mount type replacements available.

### Wide variety of connector types available



### Wide selection of models to suit a various machine tools

	For small to medium machines		For miniature machines
Application	Standard lens provides brilliant light on the <b>edges</b> of tools and <b>work pieces</b> . Diffused lens provides <b>wide light distribution</b> inside work areas.		Brightly lights <b>machine tool tips</b> and inside <b>small machines</b> .
Part no.	LF3D-S	LF3D-F	LF1D-C
Shape	Surface mount	Recessed mount	Surface mount
Luminous Flux (typ.)	1700 lm		560 lm
Reference Illuminance (typ.) at 1.0m directly below	1800 lx (standard distribution) 1000 lx (diffused distribution)		180 lx
Dimensions (W × H × D)	55.8 × 17.5 × 310 mm	80 × 27 × 307 mm	50 × 25 × 100 mm

# LF3D/LF1D LED Lighting



## LF3D LED Lighting

### LF3D

Package Quantity: 1

Model		LF3D			
Light distribution		Standard		Diffused	
Style		Surface mount (*1)	Recessed mount	Surface mount (*1)	Recessed mount
Illumination surface		Reinforced glass			
Connection direction	Cable / Connector	Part no. (Ordering no.)			
Side	5m cable	LF3D-SB2S05M	—	LF3D-SB1S05M	—
	M8 connector	LF3D-SB2S2		LF3D-SB1S2	
Rear	5m cable	—	LF3D-FB2B05M	—	LF3D-FB1B05M
			LF3D-F1B2B05M (*2)		LF3D-F1B1B05M (*2)
			LF3D-F2B2B05M (*3)		LF3D-F2B1B05M (*3)
	M12 connector	LF3D-SB2B1	LF3D-FB2B1	LF3D-SB1B1	LF3D-FB1B1
			LF3D-F1B2B1 (*2)		
			LF3D-F2B2B1 (*3)		

\*1) Contact IDEC for customers using LF1D-E (EH/EN) or LF1D-F (FH).

\*2) Size and mounting centers compatible with LF2D-E (EH/EN), (LF3D-F1)

\*3) Size and mounting centers compatible with LF2D-F (FH), (LF3D-F2)

### Performance Specifications

Model	LF3D	
Style	Uniform light source / slim type	
Light distribution	Standard	Diffused
Rated voltage	24V DC	
Operating voltage range	21.6 to 26.4V DC	
Rated Power (typ.) (at rated voltage)	9.2W	
Illumination color	Daylight	
Color temp. (typ.)	5700K	
Luminous Flux (typ.)	1700 lm	
Reference Illuminance (typ.) at 1.0m directly below	1800 lx	1000 lx
Insulation resistance	100MΩ minimum (500V DC megger)	
Dielectric strength	1000V AC, 50/60Hz, 1 minute	
Vibration resistance (damage limits)	Frequency 5 to 55Hz, amplitude 0.5mm	
Shock resistance (damage limits)	1000m/s <sup>2</sup>	
Operating temperature	-30 to +55°C (no freezing)	
Operating relative humidity	45 to 85%RH (no condensation)	
Storage temperature	-35 to +70°C (no freezing)	
Operating atmosphere	No corrosive gas	
Light source life (*1)	50,000 hours (The illumination duration in which the brightness maintains a minimum of 70%) (Ta = 25°C, 45%RH max.)	
Degree of protection (*2)	Surface mount: IP65, IP67, IP67G, IP69K Recessed mount: IP65, IP67, IP67G	
Glare save mode (GS-Mode) (*3)	White wire (pin no.1) - open: 100% light on White wire (pin no.1) and brown wire (pin no. 2) - short-circuit: dim light	
Material (Main parts)	Main body: Aluminum Front cover (surface mount): Stainless steel Flange (recessed mount): Aluminum Side cover: Zinc die-cast (plating) Illumination part surface: Reinforced glass Gasket: NBR	
Weight (approx.)	LF3D-S: 680g (*4) LF3D-F: 770g (*4)	LF3D-F1: 830g (*4) LF3D-F2: 870g (*4)
Light Distribution Curve (reference value) (unit: cd/1000 lm)		

• Due to variations in LED elements, products may vary in illumination color and illuminance.

\*1) Not a guaranteed value. The actual life may differ depending on the operating environment and conditions. Specifications are subject to change without notice.

Ta is the ambient temperature of this product.

\*2) Testing conditions specified by IEC60529 (IP67), JIS C 0920 (IP67F/IP67G), and DIN40050-9 (IP69K)

Not guaranteed for every operating condition (the rated value of the protective structure is when the product is mounted.)

\*3) Dimming differs according to the operating environment. Not a fixed value. (Ta=25°C typ.)

\*4) Weight of cable type.

### Cross-sectional direction of light distribution

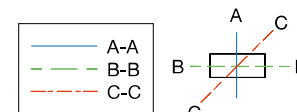

### Internal Circuit

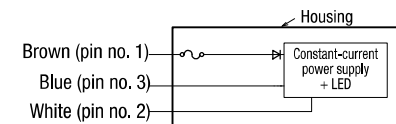

## LF1D LED Lighting

## LF1D-C

Package Quantity:

Model		LF1D-C
Mount style		Surface mount
Illumination surface		Reinforced glass
Cable direction	Cable length	Part no. (Ordering no.)
Side	3m	LF1D-C2F-2W-330
	5m	LF1D-C2F-2W-350
Rear	3m	LF1D-C2F-2W-430
	5m	LF1D-C2F-2W-450

## Performance Specifications

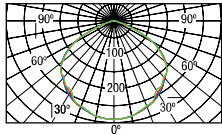
Model	LF1D-C
Style	Mini
Light distribution	Diffused
Rated voltage	24V DC
Operating voltage range	21.6 to 26.4V DC
Rated Power (typ.) (at rated voltage)	4.6W
Illumination color	White
Color temp. (typ.)	5700K
Luminous Flux (typ.)	560 lm
Reference Illuminance (typ.) at 1.0m directly below	180 lx
Insulation resistance	100MΩ minimum (500V DC megger)
Dielectric strength	1000V AC 50/60Hz, 1 minute
Vibration resistance (damage limits)	Frequency 5 to 55 Hz, amplitude 0.5 mm
Shock resistance (damage limits)	1000m/s <sup>2</sup>
Operating temperature	-30 to +55°C (no freezing)
Operating relative humidity	45 to 85%RH (no condensation)
Storage temperature	-35 to +70°C (no freezing)
Operating atmosphere	No corrosive gas
Light source life (*1)	50,000 hours (The illumination duration in which the illuminance maintains a minimum of 70% of the initial value. Ta=25°C, 45%RH max.)
Degree of protection (*2)	IP67, IP67F, IP69K
Material (Main parts)	Housing: aluminum Front cover: stainless steel Lens: reinforced glass
Weight (approx.)	LF1D-C2F-2W-350: 420g
Light Distribution Curve (reference value) (unit: cd/1000 lm)	

• Due to variations in LED elements, products may vary in illumination color and illuminance.

\*1) Not a guaranteed value. The actual life may differ depending on the operating environment and conditions. Specifications are subject to change without notice.

Ta is the ambient temperature of this product.

\*2) Testing conditions specified by IEC60529 (IP67), JIS C 0920 (IP67F/IP67G), and DIN40050-9 (IP69K)

Not guaranteed for every operating condition (the rated value of the protective structure is when the product is mounted.)

## Cross-sectional direction of light distribution

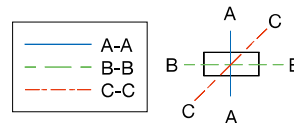

## Internal Circuit

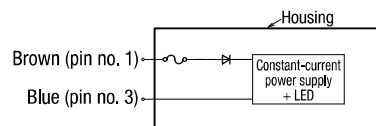

Dimensions (LF3D)

Dimensions in mm

LF3D (surface mount)

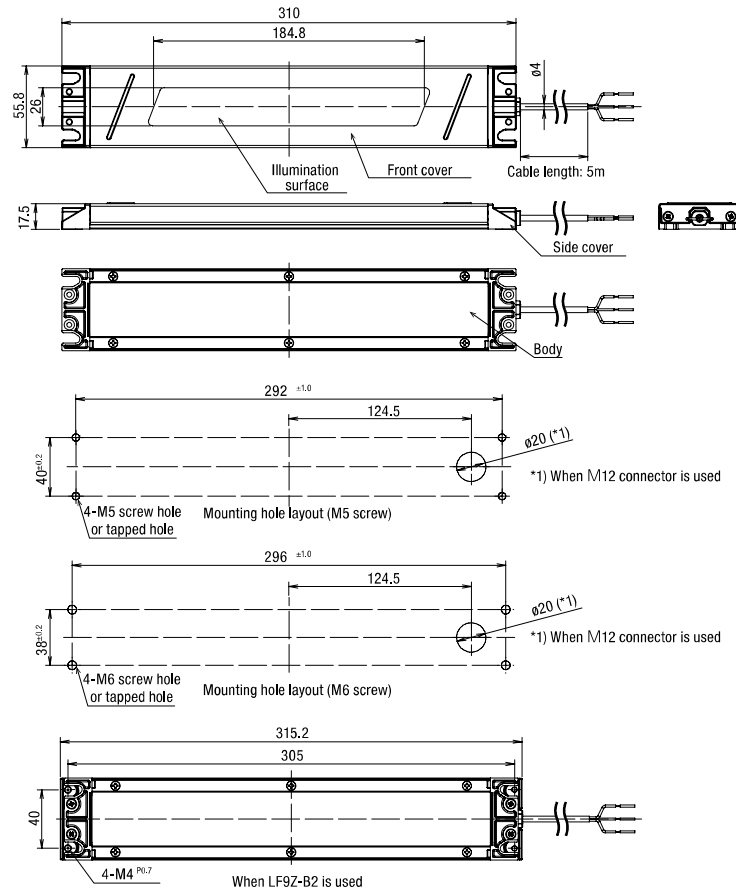

5m cable

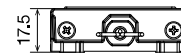

M8 connector

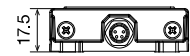

M12 connector

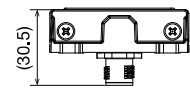

Connector Wiring

M8 connector

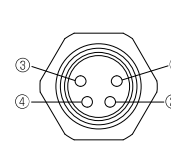

M12 connector (A coding)

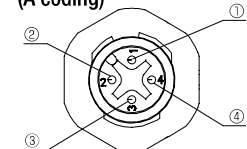

Use a connector on a power supply side that satisfies the required degree of protection.  
Recommended connector: Harting (M8 connector)  
Phoenix Contact (M12 connector)

Pin No.	Wiring color	Function	Connection
①	Brown	+DC	Power Supply +24V
②	White	GS Mode	Open or +DC
③	Blue	-DC	Power Supply 0V(GND)
④	-	N.C.	

LF3D (recessed mount)

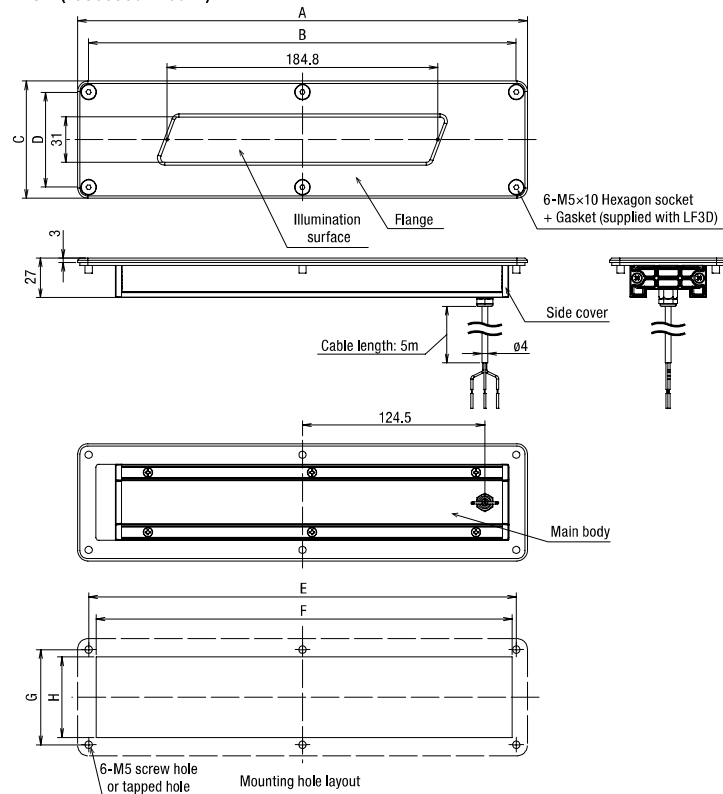

5m cable type

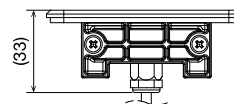

M12 connector type

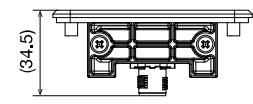

Dimensions (mm)			
Model	LF3D-F	LF3D-F1	LF3D-F2
A	307	389	308
B	292	374	293
C	80	80	105
D	65	65	90
E	292	374	293
F	284	366	286
G	65	65	90
H	55	55	80

Connector Wiring

M12 connector type (A coding)

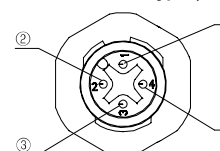

Use a connector on a power supply side that satisfies the required degree of protection.  
Phoenix Contact (M12 connector)

Pin no.	Wiring color	Function	Connection
①	Brown	+DC	Power Supply +24V
②	White	GS Mode	Open or +DC
③	Blue	-DC	Power Supply 0V(GND)
④	-	N.C.	



Dimensions (LF1D)

Dimensions in mm

Note: For mounting hole layout and the size of mounting screws on the back of the LED unit, see the specification sheet and dimensions supplied with the product.

LF1D-C (mini model)

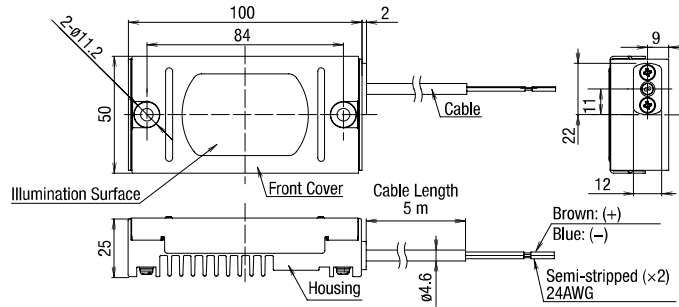

Accessories (LF3D)

Accessories exclusive for LF3D

Item	Shape	Type	Part no. (Ordering no.)	Package quantity	Remarks
Mounting Bracket		Side connection	LF9Z-B21	2 (for right and left, supplied with mounting screws)	Bracket used for mounting LF1D-E (EN/EH) from the back with the same mounting centers.
		Back connection	LF9Z-B22	2 (for right and left, supplied with mounting screws)	
M12 connector cable		Straight	LF9Z-CM13	1	Length: 3m
		Right angle	LF9Z-CM23	1	

• Accessories are not supplied with the product.

## ⚠ Safety Precautions

- Do not disassemble, repair, or modify the product. Otherwise electric shock, fire, or malfunction may occur.
- Turn off power before wiring. Make sure that the temperature has lowered sufficiently before wiring.
- To prevent electric shock or damage, ensure that the wiring is correct.
- Do not stare directly into the LED while it is lit, and do not project the light towards other people, otherwise eyes may be injured.
- The product is a general-purpose industrial electric device.
- Ensure correct operating temperature. Operating temperature is the ambient temperature where the product will be used. Temperature exceeding the specified value may cause rise in internal temperature and cause damage to the unit.
- When using this product as part of or in connection with electrical equipment for general use (\*), use a DC power supply unit with a PSE mark that conforms to the technical standards of the Product Safety Electrical Appliance & Material (PSE). For installation, follow the laws and regulations such as technical standards for electrical equipment and construction equipment standards.  
\*) Electrical facilities mainly for general residences and stores, receiving AC 600V or less, and small power generation facilities.
- The product is for indoor use only. Do not use outdoors, otherwise insulation failure, electric shock, or failure may result.
- Do not use for applications which may cause harm or injury in case a malfunction or failure occurs.

## Instructions





- Due to variations in LED elements, products may vary in illumination color and illuminance.
- Before designing equipment and powering up the product, confirm the specifications described in the instruction sheet.
- Apply voltage within the rated value, otherwise the LED elements maybe damaged.
- Do not use or store in a location subject to vibration and shock, otherwise electric shock or failure will result.
- Do not loosen screws, otherwise the protection characteristics will be impaired.
- To clean the cover, use a soft cloth with water or neutral detergent. Do not use solvents such as thinners, benzene, or alkaline, otherwise, discoloration, deterioration, or decrease in strength may occur.
- When using this product in environments subject to dust and water, make sure that the wiring part of cable or wire are dustproof/water-proof. Otherwise leakage, electric shock, or failure may occur.
- Do not use in the following locations:
  - ① Locations subject to high water pressure (environments exceeding protection degree IPX5, IPX7X or IPX9K in accordance with IEC 60529.)
  - ② Locations subject to dust (environments exceeding protection degree IP6X in accordance with IEC 60529.)
  - ③ Environment subject to corrosive gases, volatile gases, flammable gases, or chemicals that could affect the safety and reliability of the product.
  - ④ Locations subject to electric or magnetic fields.
  - ⑤ Subject to flammable substances.
  - ⑥ Exposed to direct sunlight, near heaters, high temperatures.
  - ⑦ Exposed to salt water.
  - ⑧ Subject to condensation or freezing, such as cold storage warehouse or air cooler outlet (make sure that condensation or freezing do not occur).
  - ⑨ Exposed to ozone, radiation, UV or other locations where safety and reliability of the product.
- When using the product as a UL/c-UL listed product, use a Class 2 power supply.
- Some metal parts are surface treated and the appearance may vary depending on each part. Also, some scratches may appear on the surface but does not affect product performance.

## Warranty

- The warranty period is one year after delivery to the specified location.  
\*Exceptions to warranty coverage  
The warranty period is reduced to six (6) months if the product is run continuously over 20 hours.
- In the event of a failure caused by our responsibility within the above period, we will replace the product free of charge at the place where the product was purchased or delivered.  
\*Does not include expenses required for mounting, replacing, or installation work.
- The warranty does not apply if the product is used outside of the conditions described in the instruction manual and specifications.

- LED lighting have a product life.
- Because internal elements deteriorate after 8 to 10 years of installation even if they have no defects in appearance, inspection and/or replacement are recommended. Operation condition: temperature 30°C, 3,000-hour operation per year (10 hours per day). (JIS C 8105-1)
- Product life is shortened under high operating temperature or when it is lit for long hours.
- Inspection and/or cleaning by user every 6 months is recommended.
- Inspection by contractors is recommended every 3 years.
- Do not use the product for a long time without inspection, otherwise smoke, fire, or electric shock may occur.

For details on mounting, wiring, and circuit examples, see the instruction manual from the below URL.

<p>URL</p> <p>LF3D-S/F <a href="https://product.idec.com/?product=LF3D">https://product.idec.com/?product=LF3D</a></p> <p>LF3D-F1 <a href="https://product.idec.com/?product=LF3D-F1">https://product.idec.com/?product=LF3D-F1</a></p> <p>LF3D-F2 <a href="https://product.idec.com/?product=LF3D-F2">https://product.idec.com/?product=LF3D-F2</a></p> <p>LF1D-C <a href="https://product.idec.com/?product=LF1D-C">https://product.idec.com/?product=LF1D-C</a></p>	 LF3D-S/F	 LF3D-F1	 LF3D-F2	 LF1D-C
--	--	--	--	---

## Ordering Terms and Conditions

Thank you for using IDEC Products.

By purchasing products listed in our catalogs, datasheets, and the like (hereinafter referred to as "Catalogs") you agree to be bound by these terms and conditions. Please read and agree to the terms and conditions before placing your order.

### 1. Notes on contents of Catalogs

- (1) Rated values, performance values, and specification values of IDEC products listed in this Catalog are values acquired under respective conditions in independent testing, and do not guarantee values gained in combined conditions.  
Also, durability varies depending on the usage environment and usage conditions.
- (2) Reference data and reference values listed in Catalogs are for reference purposes only, and do not guarantee that the product will always operate appropriately in that range.
- (3) The specifications / appearance and accessories of IDEC products listed in Catalogs are subject to change or termination of sales without notice, for improvement or other reasons.
- (4) The content of Catalogs is subject to change without notice.

### 2. Note on applications

- (1) If using IDEC products in combination with other products, confirm the applicable laws / regulations and standards.  
Also, confirm that IDEC products are compatible with your systems, machines, devices, and the like by using under the actual conditions. IDEC shall bear no liability whatsoever regarding the compatibility with IDEC products.
- (2) The usage examples and application examples listed in Catalogs are for reference purposes only. Therefore, when introducing a product, confirm the performance and safety of the instruments, devices, and the like before use. Furthermore, regarding these examples, IDEC does not grant license to use IDEC products to you, and IDEC offers no warranties regarding the ownership of intellectual property rights or non-infringement upon the intellectual property rights of third parties.
- (3) When using IDEC products, be cautious when implementing the following.
  - i. Use of IDEC products with sufficient allowance for rating and performance
  - ii. Safety design, including redundant design and malfunction prevention design that prevents other danger and damage even in the event that an IDEC product fails
  - iii. Wiring and installation that ensures the IDEC product used in your system, machine, device, or the like can perform and function according to its specifications
- (4) Continuing to use an IDEC product even after the performance has deteriorated can result in abnormal heat, smoke, fires, and the like due to insulation deterioration or the like. Perform periodic maintenance for IDEC products and the systems, machines, devices, and the like in which they are used.
- (5) IDEC products are developed and manufactured as general-purpose products for general industrial products. They are not intended for use in the following applications, and in the event that you use an IDEC product for these applications, unless otherwise agreed upon between you and IDEC, IDEC shall provide no guarantees whatsoever regarding IDEC products.
  - i. Use in applications that require a high degree of safety, including nuclear power control equipment, transportation equipment (railroads / airplanes / ships / vehicles / vehicle instruments, etc.), equipment for use in outer space, elevating equipment, medical instruments, safety devices, or any other equipment, instruments, or the like that could endanger life or human health
  - ii. Use in applications that require a high degree of reliability, such as provision systems for gas / waterworks / electricity, etc., systems that operate continuously for 24 hours, and settlement systems
  - iii. Use in applications where the product may be handled or used deviating from the specifications or conditions / environment listed in the Catalogs, such as equipment used outdoors or applications in environments subject to chemical pollution or electromagnetic interference  
If you would like to use IDEC products in the above applications, be sure to consult with an IDEC sales representative.

### 3. Inspections

We ask that you implement inspections for IDEC products you purchase without delay, as well as thoroughly keep in mind management/maintenance regarding handling of the product before and during the inspection.

### 4. Warranty

#### (1) Warranty period

The warranty period for IDEC products shall be one (1) year after purchase or delivery to the specified location. However, this shall not apply in cases where there is a different specification in the Catalogs or there is another agreement in place between you and IDEC.

#### (2) Warranty scope

Should a failure occur in an IDEC product during the above warranty period for reasons attributable to IDEC, then IDEC shall replace or repair that product, free of charge, at the purchase location / delivery location of the product, or an IDEC service base. However, failures caused by the following reasons shall be deemed outside the scope of this warranty.

- i. The product was handled or used deviating from the conditions / environment listed in the Catalogs
  - ii. The failure was caused by reasons other than an IDEC product
  - iii. Modification or repair was performed by a party other than IDEC
  - iv. The failure was caused by a software program of a party other than IDEC
  - v. The product was used outside of its original purpose
  - vi. Replacement of maintenance parts, installation of accessories, or the like was not performed properly in accordance with the user's manual and Catalogs
  - vii. The failure could not have been predicted with the scientific and technical standards at the time when the product was shipped from IDEC
  - viii. The failure was due to other causes not attributable to IDEC (including cases of force majeure such as natural disasters and other disasters)
- Furthermore, the warranty described here refers to a warranty on the IDEC product as a unit, and damages induced by the failure of an IDEC product are excluded from this warranty.

### 5. Limitation of liability

The warranty listed in this Agreement is the full and complete warranty for IDEC products, and IDEC shall bear no liability whatsoever regarding special damages, indirect damages, incidental damages, or passive damages that occurred due to an IDEC product.

### 6. Service scope

The prices of IDEC products do not include the cost of services, such as dispatching technicians. Therefore, separate fees are required in the following cases.

- (1) Instructions for installation / adjustment and accompaniment at test operation (including creating application software and testing operation, etc.)
- (2) Maintenance inspections, adjustments, and repairs
- (3) Technical instructions and technical training
- (4) Product tests or inspections specified by you

The above content assumes transactions and usage within your region. Please consult with an IDEC sales representative regarding transactions and usage outside of your region. Also, IDEC provides no guarantees whatsoever regarding IDEC products sold outside your region.

# Machine tools industry solutions

Find out how IDEC has solved customers' problems in the machine tools industry.

## Related products

A wide variety of safety switches covers small to large-size machine tools



Interlock switches with solenoid

HS5L HS1T



HS5L: 4-contact switches suitable for small doors. 2-contact switches suitable for food machinery and injection molding machines.

HS1T: 5000N locking strength is suitable for large machines and equipment, ensuring operator safety.

Compact safety pressure sensitive switch conforming to ISO13856-2



Safety edge switches

E30BK1



Conforms to ISO 13856-2 (pressure-sensitive protective devices). Ensures safety without reducing the opening/closing speed of automatic doors. The rubber part is made of oil-resistant NBR material, suitable for environments where oil mist is dispersed.

Diagnose and monitor safety systems



Safety relay modules

HR6S



Safety relay module to monitor and diagnose safety systems. Improves productivity by predictive maintenance of safety systems.

Reduce the cost of relay replacement



Slim power relays

RJ

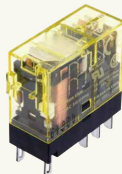

Durable and compact slim power relays with high contact allowable current.

Prevent momentary stops that cause machine failures

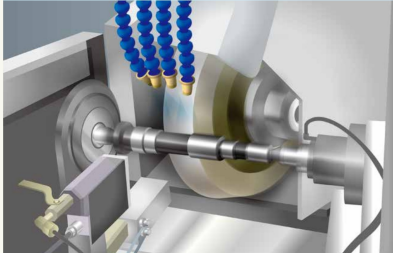

Switching power supplies

PS5R-V



High performance DIN rail power supplies with low profile, space saving 6-direction mounting, and spring-up terminals for wiring efficiency and safety. Mounting brackets are also available for direct mounting. Compliant with SEMI-F47 standards. (Certified for 208V AC input voltage.)

Smart RFID reader to manage user authority/log control

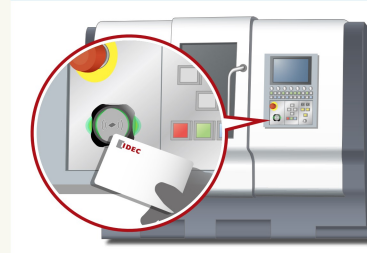

Smart RFID reader

KW2D



The compact RFID reader mounts on ø22 panel cut-out. Water- and oil-proof with verification functions. Suitable for controlling and tracking access to production sites.

# IDEC CORPORATION

Head Office 6-64, Nishi-Miyahara-2-Chome, Yodogawa-ku, Osaka 532-0004, Japan

USA IDEC Corporation  
EMEA APEM SAS

Singapore IDEC Izumi Asia Pte. Ltd.  
Thailand IDEC Asia (Thailand) Co., Ltd.  
India IDEC Controls India Private Ltd.

China IDEC (Shanghai) Corporation  
IDEC Izumi (H.K.) Co., Ltd.  
Taiwan IDEC Taiwan Corporation

Japan IDEC Corporation

 [www.idec.com](http://www.idec.com)

Specifications and other descriptions in this brochure are subject to change without notice.  
Information in this brochure is current as of April, 2022.  
2022 IDEC Corporation, All Rights Reserved.  
EP1745-3

